

深圳市天祥瑞实业有限公司

SHENZHEN TIANXIANGRUI INDUSTRIAL Co., Ltd

地址：深圳市宝安82区新湖路华丰科技园

PC：518000

ADD：HuaFengKeJIYuan，Xinhu Road, Bao'an District, Shenzhen, China

Tel: 29563809/29563810 Fax: 29657080 E-mail: txr4168@163.com Website: www.sztxr.com

规格参数 SPECIFICATIONS

电池型号 Model No:	CR2016
标称电压 Nominal Voltage	3 Volt
标称容量 (30KΩ 欧连续放电) 约 Nominal Capacity Around	80 mAh
重量约 Weight Around	1.8 gr
工作电流约 Recommended Drain Around	0.1 mA

DIMENSIONS:

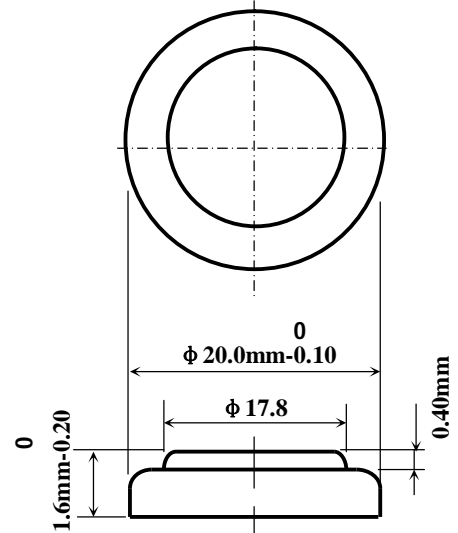

主要材料 MAJOR MATERIALS

正极物质主要是二氧化锰，负极物质主要是金属锂，电解质是有机溶液。其化学体系为：(-) Li/LiClO₄+PC+DME/MnO₂ (+)

The positive material is manganese dioxide, the negative material is lithium, and the electrolyte is organic solvent.

标准曲线 STANDARD CHARACTERISTICS

