

# 深圳市天祥瑞实业有限公司

SHENZHEN TIANXIANGRUI INDUSTRIAL Co., Ltd

地址：深圳市宝安82区新湖路华丰科技园

PC：518000

ADD：HuaFengKeJiYuan，Xinhu Road, Bao'an District, Shenzhen, China

Tel: 29563809/29563810 Fax: 29657080 E-mail: txr4168@163.com Website: www.sztxr.com

## 规格参数 SPECIFICATIONS

电池型号 Model No:	<b>CR2032</b>
标称电压 Nominal Voltage	<b>3 Volt</b>
标称容量 (15K $\Omega$ 欧连续放电) 约 Nominal Capacity Around	<b>220 mAh</b>
重量约 Weight Around	<b>3.1 gr</b>
工作电流约 Recommended Drain Around	<b>0.2 mA</b>

## DIMENSIONS:

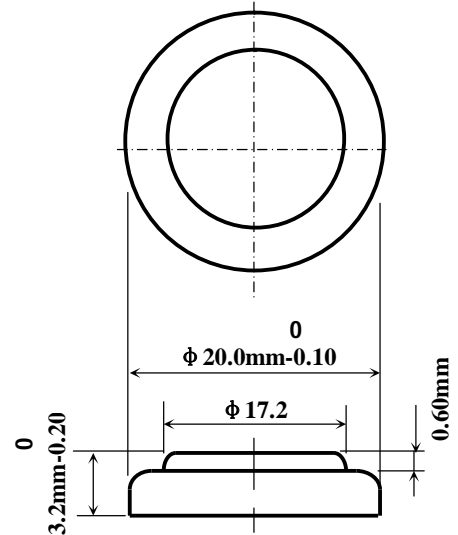

## 主要材料 MAJOR MATERIALS

正极物质主要是二氧化锰，负极物质主要是金属锂，电解质是有机溶液。其化学体系为：  
(-) Li/LiClO<sub>4</sub>+PC+DME/MnO<sub>2</sub> (+)

The positive material is manganese dioxide, the negative material is lithium, and the electrolyte is organic solvent.

## 标准曲线 STANDARD CHARACTERISTICS

