

# 深圳市天祥瑞实业有限公司

SHENZHEN TIANXIANGRUI INDUSTRIAL Co., Ltd

地址：深圳市宝安82区新湖路华丰科技园

PC：518000

ADD：HuaFengKeJIYuan，Xinhu Road, Bao'an District, Shenzhen, China

Tel: 29563809/29563810 Fax: 29657080 E-mail: txr4168@163.com Website: www.sztxr.com

## AG5/LR754 BUTTON CELL

### DIMENSIONS:

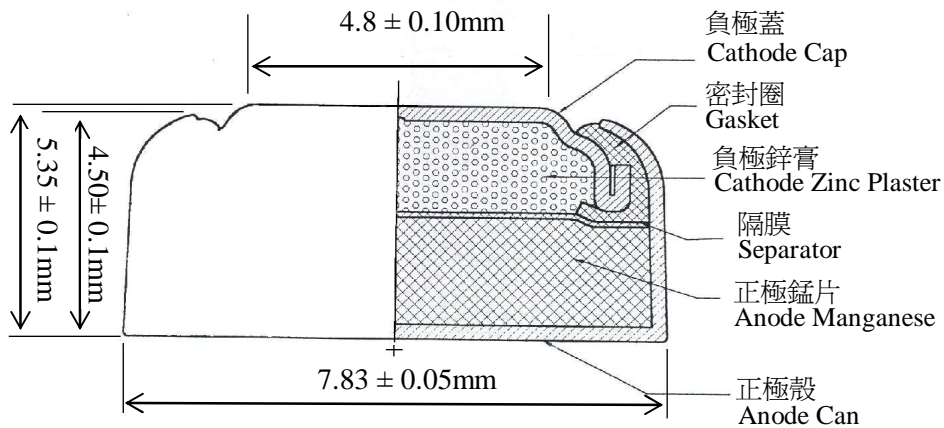

**NOMINAL VOLTAGE : 1.5 VOLT**

**APPROX. SERVICE CAPACITY : 68 mAh**

**APPROX. WEIGHT : 0.9 g**

**RATED AT 15,000 OHMS LOAD TESTED AT 21 C WITHIN 30 DAYS OF MANUFACTURE.**

**SYSTEM : ZINC/MANGANESE DIOXIDE.**

### ESTIMATED AVERAGE HOURS SERVICE AT 21 C

